

Shank adapters

Hexagonal shank adapters

	Thread	Length	Flushing Hole	Weight	Part No.
		mm	mm	kg	

For hexagonal bushing 22 x 108 mm

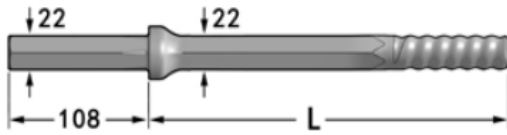

R22	120	6	0.8	21H22-R22/108-120-40
R22	180	6	1	21H22-R22/108-180-40
R22	200	6	1.1	21H22-R22/108-200-40
R22	291	6	1.3	21H22-R22/108-291-40
R22	360	6	1.5	21H22-R22/108-360-40
R22	460	6	1.8	21H22-R22/108-460-40
R22	500	6	1.9	21H22-R22/108-500-40

R25	255	7	1.5	21H22-R25/108-255-40
R25	270	7	1.6	21H22-R25/108-270-40
R25	300	7	1.7	21H22-R25/108-300-40
R25	310	7	1.7	21H22-R25/108-310-40
R25	400	7	2.1	21H22-R25/108-400-40
R25	650	7	3.1	21H22-R25/108-650-40
R25	760	7	3.5	21H22-R25/108-760-40

For hexagonal bushing 25 x 108 mm

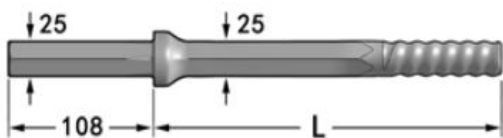

R25	255	7	1.5	21H25-R25/108-255-40
R25	600	7	2.9	21H25-R25/108-600-40
R25	800	7	3.7	21H25-R25/108-800-40
R25	1000	7	4.5	21H25-R25/108-1000-40

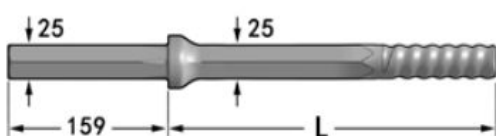

For hexagonal bushing 25 x 159mm



R25	1200	7	5.3	21H25-R25/159-1200-40
R25	1830	7	7.8	21H25-R25/159-1830-40
R25	4200	7	17.3	21H25-R25/159-4200-40
R25	4700	7	19.3	21H25-R25/159-4700-40

Shank adapters

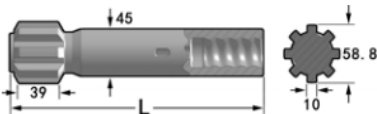
Sandvik

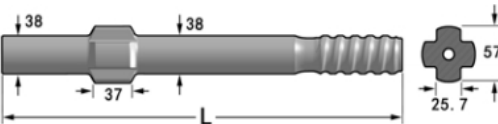
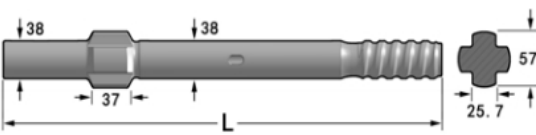
	Thread	Length	Flushing Hole	Weight	Part No.
		mm	mm	kg	
HL 300					
	R32	400		2.8	4HL300-32R32-0400-23
HL 300S					
	R28	245		2.8	4HL300-45R28-0245-23
	R32	245		2.8	4HL300-45R32-0245-23
L400, L410, L500, L510, L550					
	R32	380	10	2.2	4L400-32R32-0380-23
HLR 438L and HLR 438T					
	R32	380	10	2.7	4HL438-38R32-0380-23
	T38	400	12	3.3	4HL438-38T38-0400-23
HLR 438LS, 438TS, HL 538, HL538L, L550S					
	R32	450		3.7	4HL538-38R32-0450-23
	R38	450		3.9	4HL538-38R38-0450-23
	T38	455		4	4HL538-38T38-0455-23
	T38	545		4.7	4HL538-38T38-0545-23

Shank adapters

Sandvik

	Thread	Length	Flushing Hole	Weight	Part No.
		mm	mm	kg	

HL 500-38 / 510-38

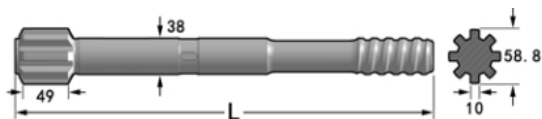

R32	550	4.2	4HL500-38R32-0550-23
T35	550	4.4	4HL500-38T35-0550-23
T38	550	4.6	4HL500-38T38-0550-23
R38	550	4.5	4HL500-38R38-0550-23

HL 500-45 / 510-45

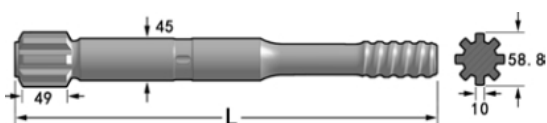

T35	550	5.6	4HL500-45T35-0550-23
T38	550	5.6	4HL500-45T38-0550-23
T45	550	5.9	4HL500-45T45-0550-23
R32	550	5.6	4HL500-45R32-0550-23

HL 500 S-38 / 510 S-38 / 510 B / 510 LH



R32	460	3.9	4HL500S-38R32-0460-23
R38	460	4.2	4HL500S-38R38-0460-23
T38	460	4	4HL500S-38T38-0460-23
R38	500	4.4	4HL500S-38R38-0500-23
T38	500	4.3	4HL500S-38T38-0500-23

HL 500 F / 510 F

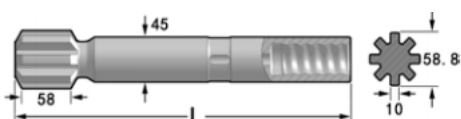

R32	350	3.9	4HL500F-45R32-0350-23
-----	-----	-----	-----------------------

Shank adapters

Sandvik

	Thread	Length	Flushing Hole	Weight	Part No.
		mm	mm	kg	

HL 550 SUPER / 560 SUPER / 510 S-45



T35	460	4.6	4HL550-45T35-0460-23
T35	550	5.6	4HL550-45T35-0550-23
R38	500	5.2	4HL550-45R38-0500-23
T38	500	5.3	4HL550-45T38-0500-23

HLX 1

HLX 1



R23	235	1	4HLX1-28R23-0235-23
R25	255	1.1	4HLX1-28R25-0255-23

HLX 5 / HLX 5T



R32	500	5.1	4HLX5-45R32-0500-23
T35	500	5.3	4HLX5-45T35-0500-23
T38	500	5.3	4HLX5-45T38-0500-23
R38	500	5.3	4HLX5-45R38-0500-23
R32	550	5.4	4HLX5-45R32-0575-23
T35	550	5.6	4HLX5-45T35-0575-23
T38	550	5.9	4HLX5-45T38-0575-23
T45	550	6.2	4HLX5-45T45-0575-23

HLX5 PE-45

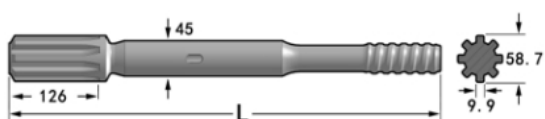

R32	575	5.9	4HLX5PE-45R32-0575-23
T38	575	6.4	4HLX5PE-45T38-0575-23

Shank adapters

Sandvik

	Thread	Length	Flushing Hole	Weight	Part No.
		mm	mm	kg	

HL 600-45 / 600 S-45

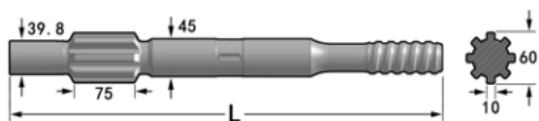

R32	600	5.7	4HL600-45R32-0600-23
T38	600	5.9	4HL600-45T38-0600-23
T45	600	6.3	4HL600-45T45-0600-23
T38	525	5.5	4HL600-45T38-0525-23
T45	525	5.8	4HL600-45T45-0525-23

HL 600-52

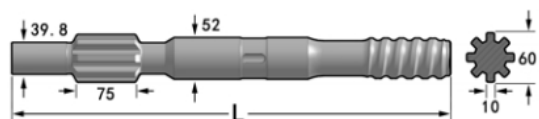

T45	650	7.6	4HL600-52T45-0650-23
T51	650	8.1	4HL600-52T51-0650-23

HL 645

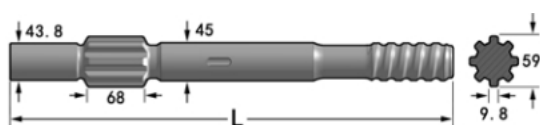

T38	600	6.6	4HL645-45T38-0600-23
T45	600	6.9	4HL645-45T45-0600-23

HL 650-45 / 700-45 / 700T-45 / 710-45 / 800T-45



T38	600	7.2	4HL650-45T38-0600-23
T45	600	7.5	4HL650-45T45-0600-23

Shank adapters

Sandvik

	Thread	Length	Flushing Hole	Weight	Part No.
		mm	mm	kg	

HL 650-52, 700-52 / PE-52 / S-52, 710-52 / S-52 / PE-52 / SPE-52, 800T-52 / PE-52

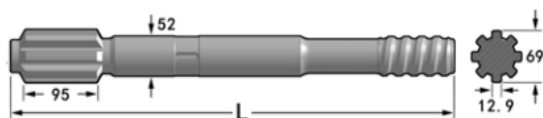

T38	600	8.4	4HL650-52T38-0600-23
T45	600	8.5	4HL650-52T45-0600-23
T51	600	8.6	4HL650-52T51-0600-23

HL 850S

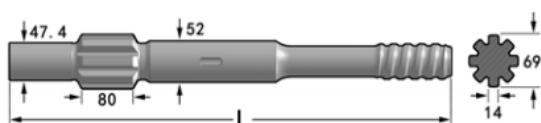

T45	670	9.1	4HL850-52T45-0670-23
T51	670	9.6	4HL850-52T51-0670-23

HL 1000-52 / 1000 S-52

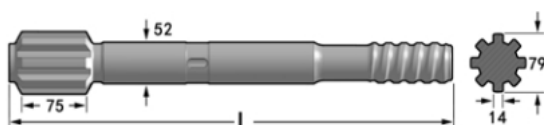

T45	670	9.7	4HL1000-52T45-0670-23
T51	670	10.1	4HL1000-52T51-0670-23
T45	590	8.9	4HL1000-52T45-0590-23
T51	590	9.3	4HL1000-52T51-0590-23



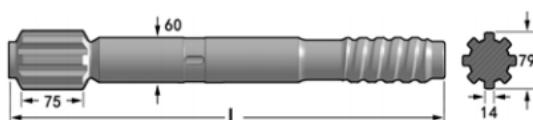

HL 1000-60 / HL 1010-60



T51	670	11.9	4HL1000-60T51-0670-23
GT60	670	12.9	4HL1000-60GT60-0670-23

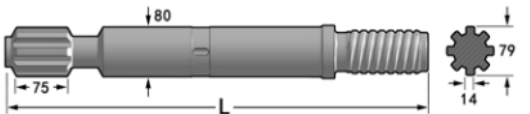

Shank adapters

Sandvik

	Thread	Length	Flushing Hole	Weight	Part No.
		mm	mm	kg	
HL 1000-80, Shoulder drive					
	GT60	670		20.8	4HL1000-80GT60-0670-23
HL 1000 S-80 Tube drilling					
	ST58	635		17.4	4HL1000-80ST58-0635-23
	ST68	640		17.9	4HL1000-80ST68-0640-23
HL 1000 PE-52					
	T51	840		13.9	4HL1000-52T51-0840-23
HL 1000 PE-65 / HL 1500 PE-65 / HL 1560 T-65					
	T51	760		15.9	4HL1000-65T51-0760-23
	GT60	760		16.7	4HL1000-65GT60-0760-23
HL 1500-52 / 1500 T-52					
	T51	710		11.2	4HL1500-52T51-0710-23

Shank adapters

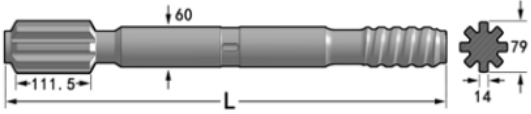
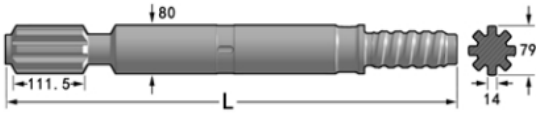
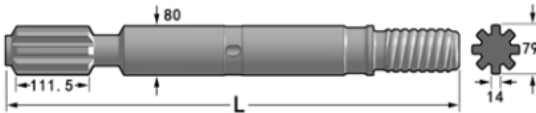
Sandvik

	Thread	Length	Flushing Hole	Weight	Part No.
		mm	mm	kg	
HL 1500-60 / 1500 T-60					
	T51	760		13.3	4HL1500-60T51-0760-23
	GT60	760		14.6	4HL1500-60GT60-0760-23
HL 1500 T-80, Shoulder drive					
	GT60	760		20.5	4HL1500-80GT60-0760-23
HL 1500 S-80 Tube drilling					
	ST58	635		17	4HL1500-80ST58-0635-23
	ST68	635		17	4HL1500-80ST58-0635-23
HL 1500 SPE-90 Tube drilling					
	ST58	635		22	4HL1500-90ST58-0635-23
	ST68	635		22.4	4HL1500-90ST68-0635-23
	GT60	760		23.5	4HL1500-90GT60-0635-23

Shank adapters

Atlas Copco

	Thread	Length	Flushing Hole	Weight	Part No.
		mm	mm	kg	

Atlas Copco BBC 43, 44, 45 and 100



R32	380	10	2.0	4BBC43-32R32-0380-23
-----	-----	----	-----	----------------------

Atlas Copco BBC 51, 52, 54 and 120



R32	380	10	2.6	4BBC51-38R32-0380-23
T38	390	10	3.0	4BBC51-38T38-0390-23

Atlas Copco BBE 57

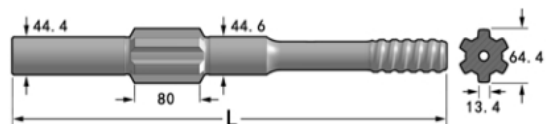

T38	537	14	5.4	4BBE57-44T38-0537-23
-----	-----	----	-----	----------------------

Atlas Copco COP 125, 130 and 131

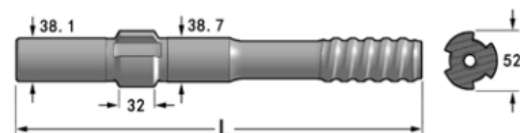

T38	380	14	13.9	4125-38T38-0380-23
-----	-----	----	------	--------------------

Atlas Copco COP 1032 HD

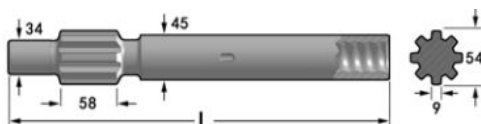

R32	340		3.3	41032HD-45R32-0340-23
-----	-----	--	-----	-----------------------

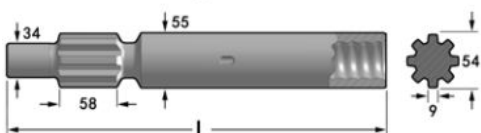

R38	340		4.1	41032HD-55R38-0340-23
-----	-----	--	-----	-----------------------

Shank adapters

Atlas Copco

	Thread	Length	Flushing Hole	Weight	Part No.
		mm	mm	kg	

Atlas Copco COP 1032

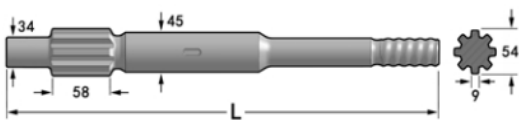

R32	550	5.1	41032-45R32-0550-23
T35	550	5.1	41032-45T35-0550-23
R38	550	5.3	41032-45R38-0550-23
T38	550	5.3	41032-45T38-0550-23

Atlas Copco COP 1036/1038 HB



R32	500	4.1	41036-38R32-0500-23
T38	500	4.5	41036-38T38-0500-23



T45	500	5.1	41036-45T45-0500-23
-----	-----	-----	---------------------

Atlas Copco COP 1038 HD/1238

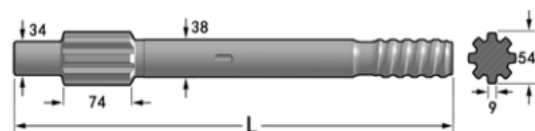

R32	485	4	41238-38R32-0485-23
R38	485	4.2	41238-38R38-0485-23
T38	485	4.2	41238-38T38-0485-23

Atlas Copco COP 1038 HL



R32	575	4.7	41038HL-38R32-0575-23
T38	575	4.9	41038HL-38T38-0575-23



T45	575	5.9	41038HL-45T45-0575-23
-----	-----	-----	-----------------------

Shank adapters

Atlas Copco

	Thread	Length	Flushing Hole	Weight	Part No.
		mm	mm	kg	

Atlas Copco COP 3038

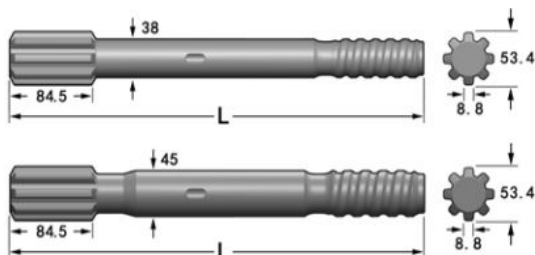

T38	435	4	43038-38T38-0435-23
T45	435	4.6	43038-45T45-0435-23

Atlas Copco COP 1238

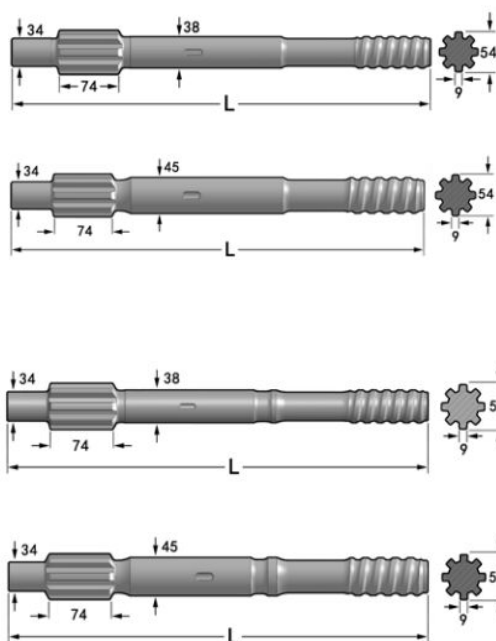

R32	500	4.2	41238-38R32-0500-23
T38	500	4.8	41238-38T38-0500-23
R38	485	4.3	41238-38R38-0485-23
T38	485	4.2	41238-38T38-0485-23
T45	500	5.2	41238-45T45-0500-23
R32	575	4.7	41238-38R32-0575-23
T35	575	4.6	41238-38T35-0575-23
T38	575	4.8	41238-38T38-0575-23
T38	575	5.5	41238-45T38-0575-23
T45	575	5.9	41238-45T45-0575-23

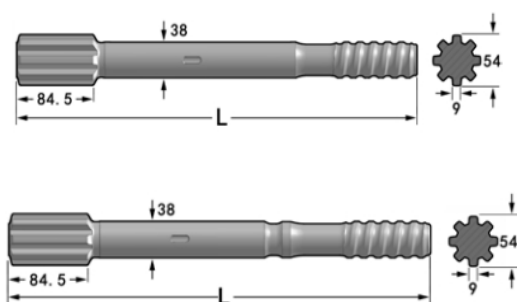

Atlas Copco COP 1432, COP 1532, COP1440, COP1838 HD/ME



R32	435	3.8	41432-38R32-0435-23
R38	435	3.9	41432-38R38-0435-23
T35	435	3.8	41432-38T35-0435-23
T38	435	3.8	41432-38T38-0435-23
R32	525	4.1	41432-38R32-0525-23
T35	525	4.2	41432-38T35-0525-23
T38	525	4.4	41432-38T38-0525-23

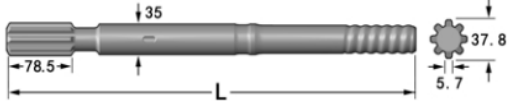
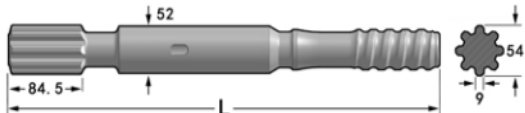

Shank adapters

Atlas Copco

	Thread	Length	Flushing Hole	Weight	Part No.
		mm	mm	kg	
Atlas Copco COP 1432 Female					
	R32	341		4.3	41432-55R32-0341-23
	R38	341		4.7	41432-55R38-0341-23
Atlas Copco COP 1132					
	R32	500		3.1	41132-35R32-0500-23
Atlas Copco COP 1550, COP 1838 ME/ HE Atlas Copco COP 1550 EX, COP 1838 EX					
	T38	525		6.1	41550-52T38-0525-23
	T45	525		6.4	41550-52T45-0525-23
	T51	525		6.8	41550-52T51-0525-23
Atlas Copco COP 1550 EX, COP 1838 EX					
	T38	730		9.9	41550EX-60T38-0730-23
	T45	730		10.3	41550EX-60T45-0730-23
Atlas Copco COP 1840 HE, COP 1850					
	T35	565		6.6	41850-52T35-0565-23
	T38	565		6.7	41850-52T38-0565-23
	T45	565		6.9	41850-52T45-0565-23
	T51	565		7.2	41850-52T51-0565-23

Shank adapters

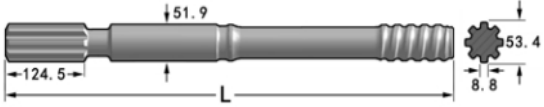
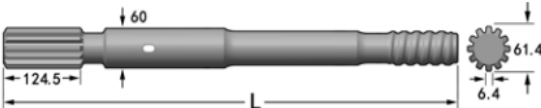
Atlas Copco

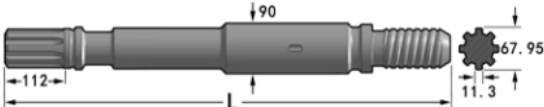
	Thread	Length	Flushing Hole	Weight	Part No.
		mm	mm	kg	
Atlas Copco COP 2150, COP 2550					
	T51	770		9.9	42150-52T51-0770-23
Atlas Copco COP 2160, COP 2560					
	T51	770		11	42160-60T51-0770-23
Atlas Copco COP 2160 EX					
	T45	770		13.2	42160EX-63T45-0770-23
	T51	770		13.3	42160EX-63T51-0770-23
Atlas Copco COP 4050 EX					
	ST68	805		21.7	44050EX-70ST68-0805-23
Atlas Copco COP 4050 MUX					
	ST68	835		26.9	44050MUX-90ST68-0835-23

Shank adapters

Gardner-Denver, Ingersoll-Rand

	Thread	Length	Flushing Hole	Weight	Part No.
		mm	mm	kg	

Gardner-Denver PR 123

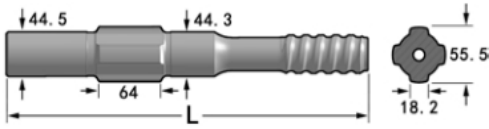

R32	330	14	3	4PR123-44R32-0330-23
R32	380	14	4.1	4PR123-44R32-0380-23
R38	350	14	3.5	4PR123-44R38-0350-23
T38	446	14	4	4PR123-44T38-0446-23
T38	380	14	3.6	4PR123-44T38-0380-23

Ingersoll-Rand URD 475, URD 550, VL120, EVL 130, VL140 and F16

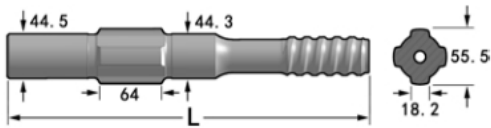

R32	330	14	3	4VL120-44R32-0330-23
R32	380	14	4.1	4VL120-44R32-0380-23
T38	380	14	3.6	4VL120-44T38-0380-23
T38	446	14	4	4VL120-44T38-0446-23

Ingersoll-Rand YH 65, YH 80

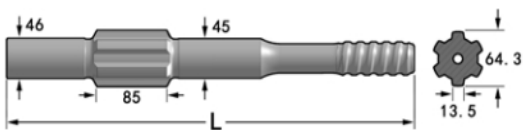

T38	495	19	5.4	4YH65-45T38-0495-23
T45	500	19	5.6	4YH65-45T45-0500-23

Ingersoll-Rand YH 80 A

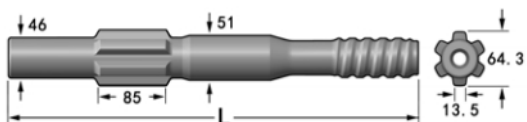

T45	495	19	6.1	4YH80A-51T45-0495-23
T51	495	19	6.4	4YH80A-51T51-0495-23

Ingersoll-Rand YH 65 RP, YH 70 RP, YH 75 RP, YH 80 RP

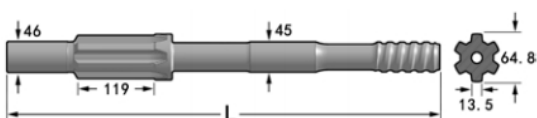

T45	700	19	7.9	4YH65RP-45T45-0700-23
-----	-----	----	-----	-----------------------

Shank adapters

Furukawa

	Thread	Length	Flushing Hole	Weight	Part No.
		mm	mm	kg	

Furukawa M 120 and PD 200

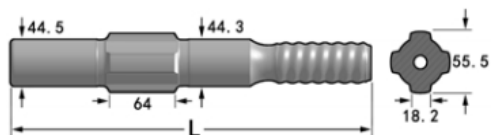

R32	330	14	3	4M120-44R32-0330-23
T38	380	14	3.6	4M120-44T38-0380-23
T38	446	14	4	4M120-44T38-0446-23

Furukawa PD 200R

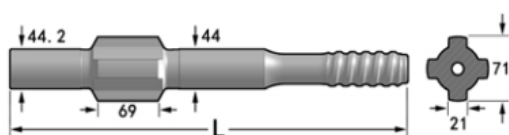

T38	484	14	5.4	4PD200R-44T38-0484-23
T45	484	14	5.2	4PD200R-44T45-0484-23

Furukawa HD 260, HD 300

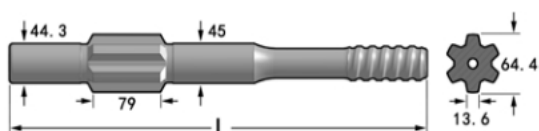

T38	655	16	6.3	4HD260-45T38-0655-23
T45	655	16	6.6	4HD260-45T45-0655-23

Furukawa HD 609

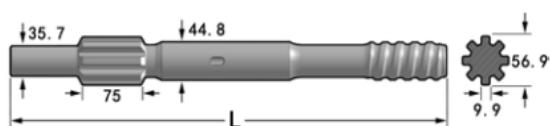

T38	620		6.1	4HD609-45T38-0620-23
T38	690		6.4	4HD609-45T38-0690-23
T45	620		6.4	4HD609-45T45-0620-23

Furukawa HD 612

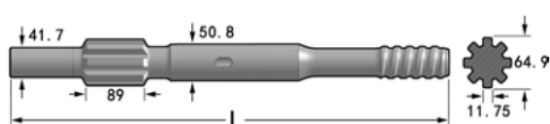

T45	710		8.9	4HD612-52T45-0710-23
-----	-----	--	-----	----------------------

Shank adapters

Furukawa

	Thread	Length	Flushing Hole	Weight	Part No.
		mm	mm	kg	

Furukawa HD 709



T38

620

6.4

4HD709-45T38-0620-23

Furukawa HD 712

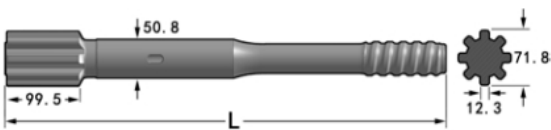

T45

788

9.6

4HD712-51T45-0788-23

Shank adapters

Montabert

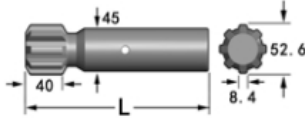
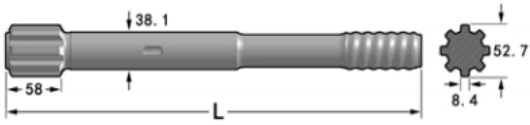
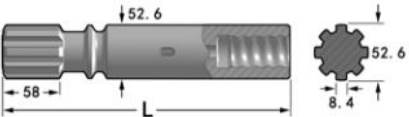
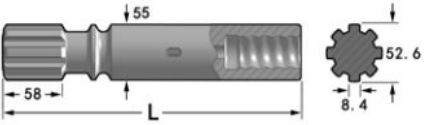
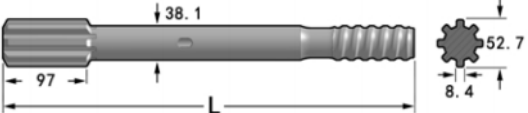
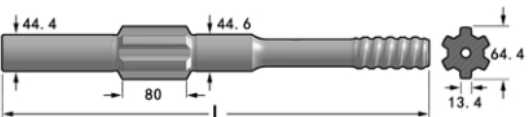
	Thread	Length	Flushing Hole	Weight	Part No.
		mm	mm	kg	
Montabert HC20 (female)					
	R32	201			4HC20-45R32-0201-23
Montabert HC40					
	R32	447		3.4	4HC40-38R32-0447-23
	R38	447		3.9	4HC40-38R38-0447-23
Montabert HC40 (female)					
	R32	270		2.9	4HC40-52R32-0270-23
	R38	320		4.1	4HC40-55R38-0320-23
Montabert HC 80, HC 90, HC 105					
	R38	440		3.9	4HC80-38R38-0440-23
	T38	440		3.9	4HC80-38T38-0440-23
	T38	500		4.1	4HC80-38T38-0500-23
Montabert H 100					
	T38	537	14	6.1	4H100-45T38-0537-23

Shank adapters

Montabert

	Thread	Length	Flushing Hole	Weight	Part No.
		mm	mm	kg	

Montabert HC 80R, HC 105R, HC 107R, HC 108R, HC 109R



T38	670	7.3	4HC80R-45T38-0670-23
T45	770	8.0	4HC80R-45T45-0770-23

Montabert HC 120, HC 150

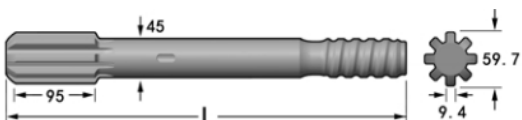

T45	490	5.6	4HC120-45T45-0490-23
-----	-----	-----	----------------------

Montabert HC 120R, HC 150R, HC 155R, HC 158R



T51	670	8.6	4HC120R-51T51-0670-23
-----	-----	-----	-----------------------

Montabert HC 200A



T51	840	16.1	4HC200A-60T51-0840-23
GT60	840	16.9	4HC200A-60GT60-0840-23

Shank adapters

SIG

	Thread	Length	Flushing Hole	Weight	Part No.
		mm	mm	kg	

SIG HBM 50, 100 and 120

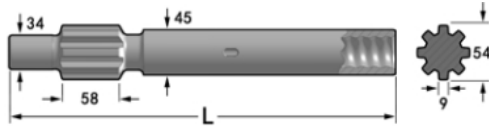

R32

340

3.3

4HBM50-45R32-0340-23

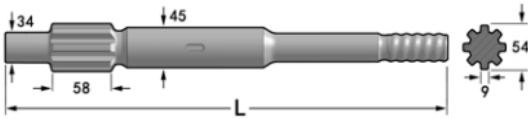

R32

550

14

4.8

4HBM50-45R32-0550-23

SIG HBM 100 and 120

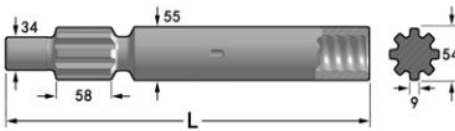

R38

340

4.1

4HBM100-55R38-0340-23

SIG 101



R32

500

4.1

4SIG101-38R32-0500-23